

# DATASHEET

## Magnetically coupled pump

### RM2 – 10/110

Motor output  
370W 1-ph. and 3-ph.  
2900 or 3450 rpm [2-pol.]



Magnetically coupled, centrifugal pumps, single-stage, horizontal, non self-priming, made in monobloc design.

		RM2 - 10/110
Motor output	[W]	370
Rated current @ 230V 50Hz 1ph.	[A]	3,4
Rated current @ 400V 50Hz 3ph.	[A]	1,35
Head max.	[mWS]	8,5
Capacity max.	[l/min.]	110
Density max. @ Qmax	[g/cm <sup>3</sup> ]	1,8
Length „L“	[mm]	310
Distance „E“	[mm]	Continuously variable 20 - 60

#### Materials:



#### Technical data

Medium-temperature max.	PP PVDF Stainless	80 °C 95 °C 100 °C
System-pressure max.	PP PVDF Stainless	1,0 bar 2,0 bar 8,0 bar
Viscosity	< 160 Pa s	
Elektrical motor	3-ph. or 1-ph. motors, 50 and 60Hz, 24V DC (direct current) Protection IP55, Isolationclass F , Chemical resistant 2K-painting RAL5011	
Options	<i>Thermal protection, other voltages / frequencies, UL, CSA, Special paintings and colors</i> 	

### Flow curves RM 2 - 10/110

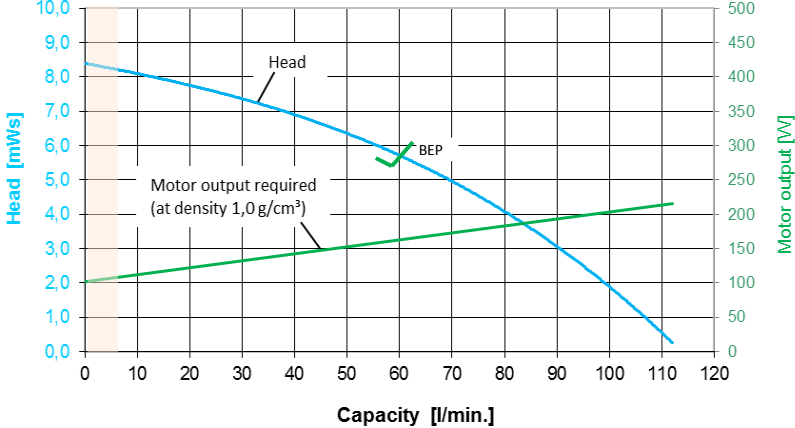

Speed: 2900 rpm @ 50Hz or 3450 rpm @ 60Hz

Values based on water at 20 °C (68 °F) / Measured value +/- 10%

Subject to technical alterations !

# DATASHEET

## Magnetically coupled pump

### RM2 – 10/110

Motor output  
370W 1-ph. and 3-ph.  
2900 or 3450 rpm [2-pol.]

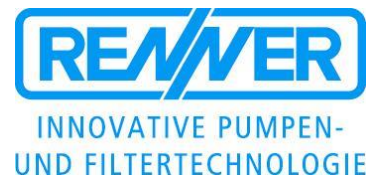

### Dimensional drawings [mm]

#### Motor output 250W – 370W

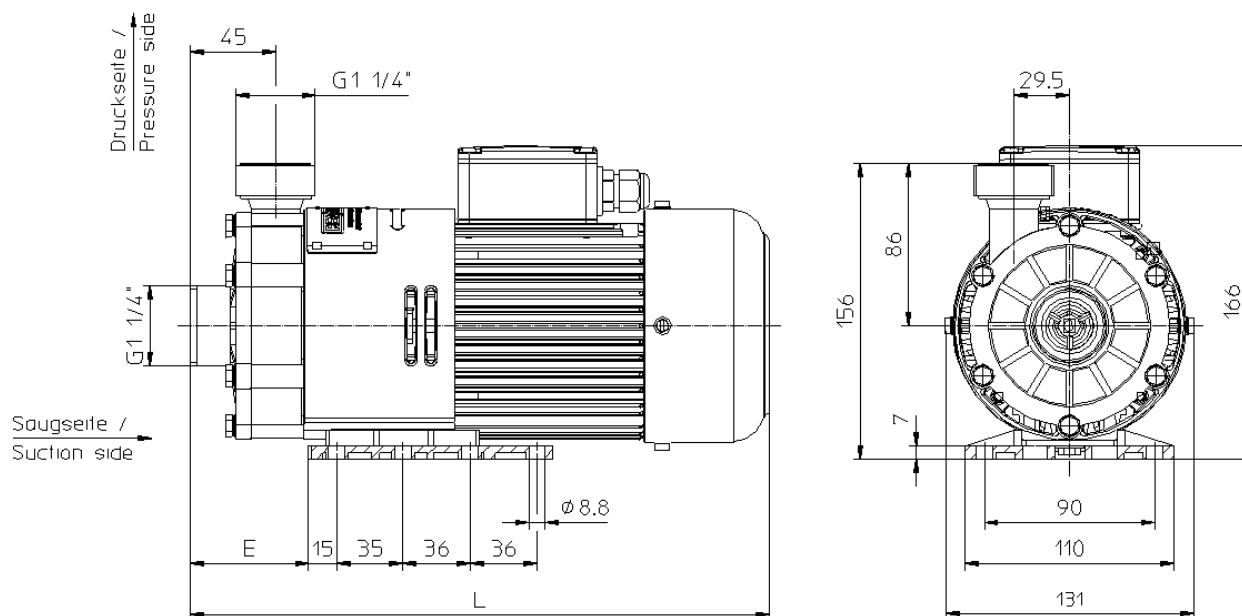

Motor dimensions can be different ! ● Subject to technical alterations !

**DATASHEET**  
**Magnetically coupled pump**

**RM2 – 10/110**

Motor output  
 370W 1-ph. and 3-ph.  
 2900 or 3450 rpm [2-pol.]

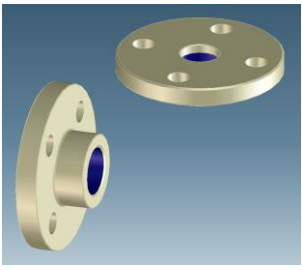
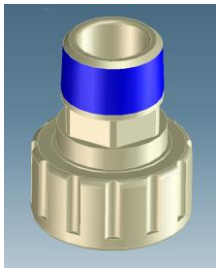

**Accessories / Options**

Hose connection	Flange (DIN, ANSI)	NPT - Adapter
 <p>13mm                      18mm                      21mm</p>	 <p>DN20 PN10 ( DIN EN 1092-3 )                      0,75" ( ANSI Class 150 )                      1" ( ANSI Class 150 )</p>	 <p>NPT (M) 1"</p>

**On-/Off - switch**



**3m cabel + plug connector**

Subject to technical alterations !