

DATASHEET

Magnetically coupled pump

RM 4 – 30/400

Motor output
2,2kW / 3,0kW / 4,0kW / 5,5kW
2950 or 3450 rpm [2-pol.]



Magnetically coupled, centrifugal pumps, single-stage, horizontal, non self-priming, made in monobloc design.

		RM4 - 30/400									
Motor output	[kW]	2,2		3,0		4,0		5,5			
Rated current @ 400V 50Hz 3ph.	[A]	4,75		6,0		8,6		10,3			
Head max.	[mWS]	27		27		27		27			
Capacity max.	[l/min.]	400		400		400		400			
Density max. @ Qmax	[g/cm³]	1,0		1,3		1,7		2,2			
Length „L“	IE2	IE3	[mm]	532	550	552	560	552	595	610	680

Materials:



Technical data

Medium-temperature max.	PP PVDF Stainless	80 °C 95 °C 100 °C	<div style="text-align: center;"> <h3>Flow curves RM4 - 30/400</h3> <p>Speed: 2950 rpm @ 50Hz or 3450 rpm @ 60Hz</p> <p>Values based on water at 20 °C (68 °F) / Measured value +/- 10%</p> </div>
System-pressure max.	PP PVDF Stainless	5,0 bar 6,0 bar 10,0 bar	
Viscosity	< 160 Pa s		
Electrical motor	3-ph. motors, 50 and 60Hz, IE2, IE3 or IE4 Protection IP55, Isolationclass F , Chemical resistant 2K- painting RAL5011		
Options	<i>Thermal protection, other voltages / frequencies, UL, CSA, Special paintings and colors</i> 		
			Subject to technical alterations !

DATASHEET

Magnetically coupled pump

RM 4 – 30/400

Motor output
2,2kW / 3,0kW / 4,0kW / 5,5kW
2950 or 3450 rpm [2-pol.]



Dimensional drawings [mm]

Motor output 2,2kW + 3,0kW + 4,0kW IE2 (also 2,2kW + 3,0kW IE3)

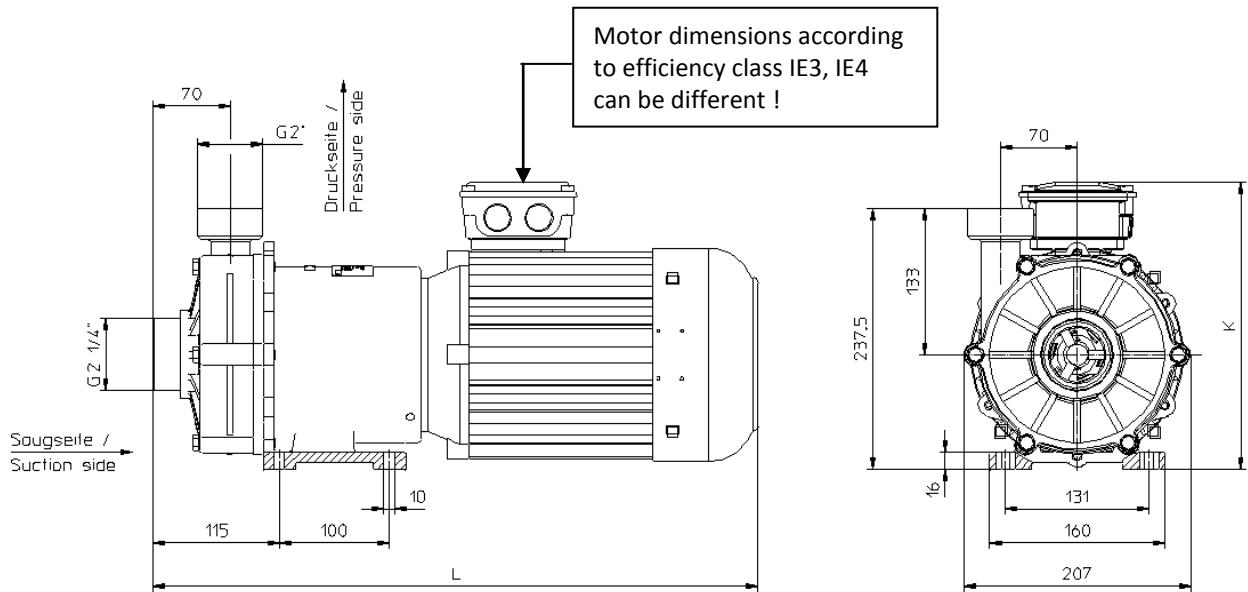

Motor output 5,5kW-IE2 and 4,0kW-IE3

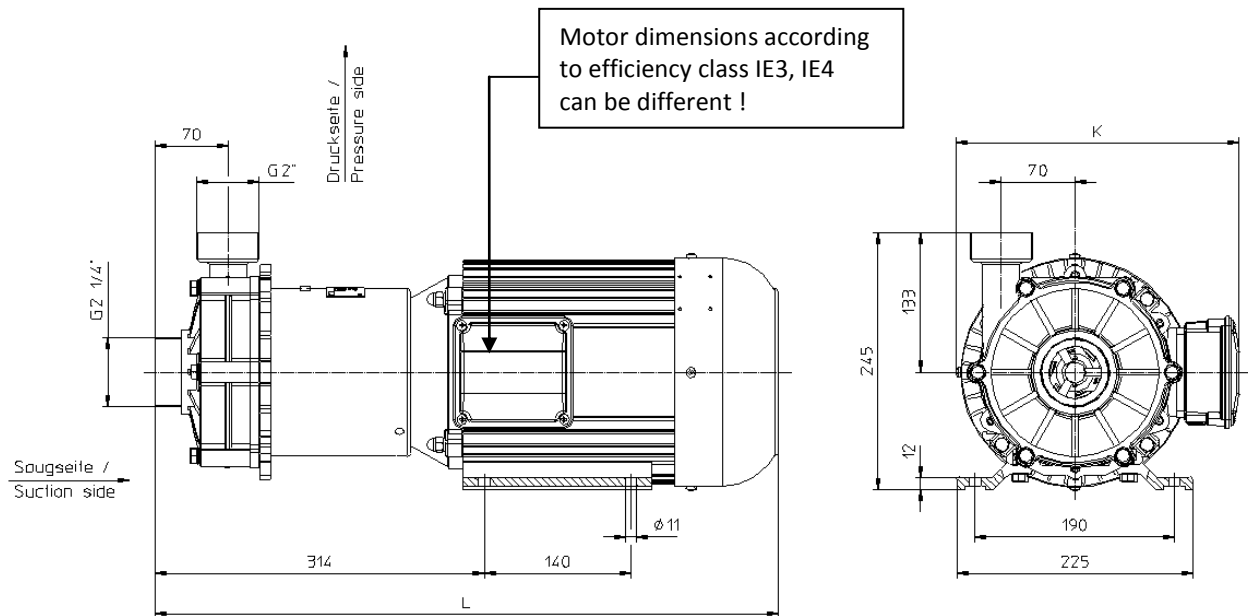

Motor dimensions can be different ! • Subject to technical alterations !

DATASHEET

Magnetically coupled pump

RM 4 – 30/400

Motor output
2,2kW / 3,0kW / 4,0kW / 5,5kW
2950 or 3450 rpm [2-pol.]

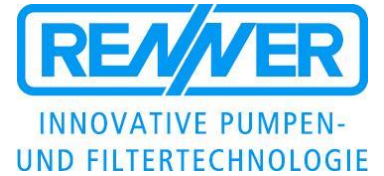

Accessories / Options

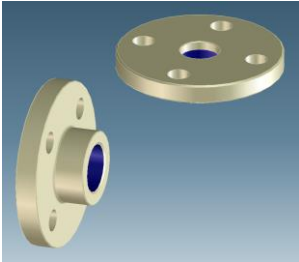
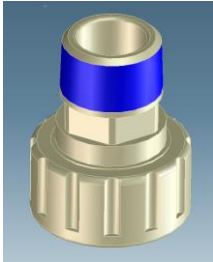
Hose connection	Flange (DIN, ANSI)	NPT - Adapter
 <p>40mm 50mm</p>	 <p>DN40 PN10 (DIN EN 1092-3) DN50 PN10 (DIN EN 1092-3) 2" (ANSI Class 150) 2" (ANSI Class 150)</p>	 <p>NPT (M) 2" NPT (M) 2.5"</p>

Monitor and protect your pump and your process !

Electronic process monitoring -> RPR-Control



- Monitoring the filter fouling
- Dry running
- Overheating
- Overload

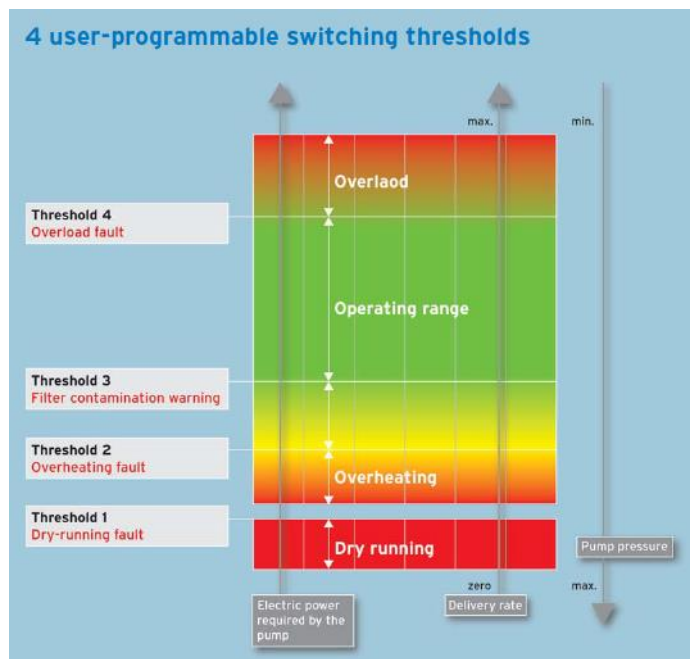

Subject to technical alterations !