

DATASHEET

Magnetically coupled pump

Motor output
2,2kW / 3,0kW



RM-MF 4 Type 22/300

Variable speed (VFD incl.)

Magnetically coupled, centrifugal pumps with variable speed drive, single-stage, horizontal, non self-priming, made in monobloc design.

		RM-MF 4 Type 22/300	
Motor output	[kW]	2,2	3,0
Voltage range	[V]	3 / PE AC 320V ... 528V	
Frequency range	[Hz]	45 ... 65	
Communication module VFD		Standard I/O (optional also with different BUS – module)	
Head max.	[mWS]	28	28
Capacity max.	[l/min.]	380	380
Density max. @ Qmax **	[g/cm³]	1,0	1,35
Length „L“	[mm]	502	502
Height „K“	[mm]	305	305
Length „B“	[mm]	445	445
Length „C“	[mm]	57	57

** For liquids with higher specific gravities all MF-pumps are available with more power !

Dimensional drawings [mm]

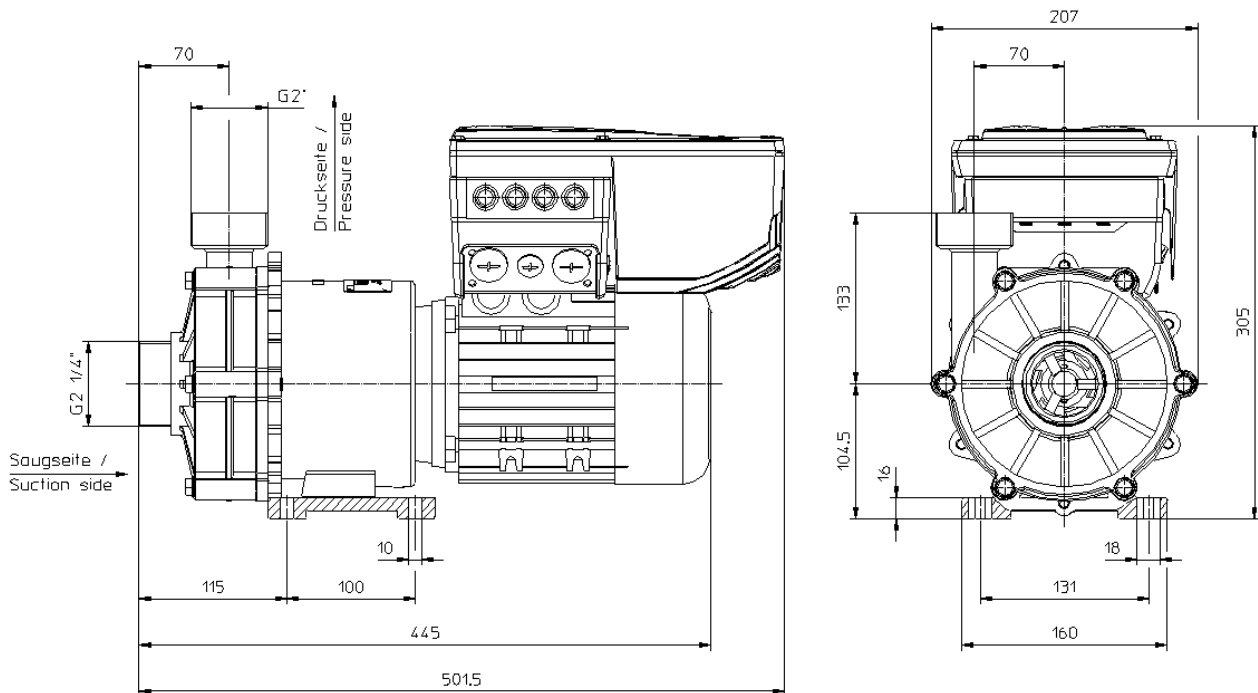

Motor dimensions can be different ! • Subject to technical alterations !

DATASHEET

Magnetically coupled pump

RM-MF 4 Type 22/300

Motor output
2,2kW / 3,0kW

Variable speed (VFD incl.)

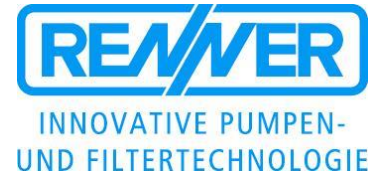

Materials:



Technical data

Medium-temperature max.	PP PVDF Stainless	80 °C 95 °C 100 °C
System-pressure max.	PP PVDF Stainless	5,0 bar 6,0 bar 10,0 bar
Viscosity	< 160 Pa s	
Electrical motor	3-ph. motors, 50 and 60Hz, IE2, IE3 or IE4 Protection IP55, Isolationclass F , Chemical resistant 2K- painting RAL5011	
Options	<i>Thermal protection, other voltages / frequencies, UL, CSA, Special paintings and colors</i> 	

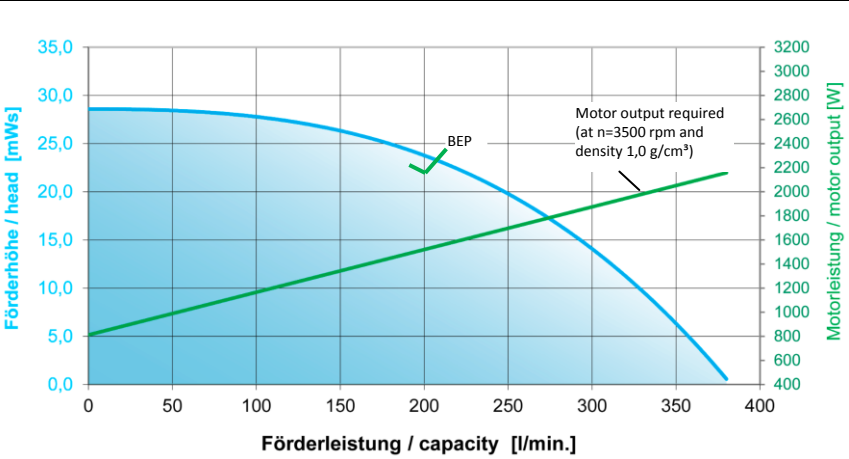

Variable speed, rated speed n=3500 rpm

Values based on water at 20 °C (68 °F) / Measured value +/- 10%

Subject to technical alterations !

DATASHEET
Magnetically coupled pump

RM-MF 4 Type 22/300

Motor output
 2,2kW / 3,0kW

Variable speed (VFD incl.)

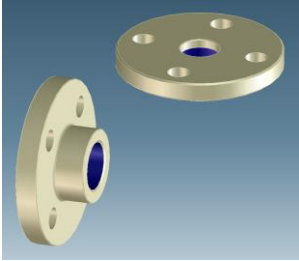
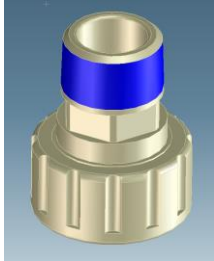

Accessories / Options

Hose connection	Flange (DIN, ANSI)	NPT - Adapter
 <p>40mm 50mm</p>	 <p>DN32 PN10 (DIN EN 1092-3) DN40 PN10 (DIN EN 1092-3) 2" (ANSI Class 150)</p>	 <p>NPT (M) 1.5" NPT (M) 2"</p>

Subject to technical alterations !